

# Sprawdziany

Gauges  
Lehren

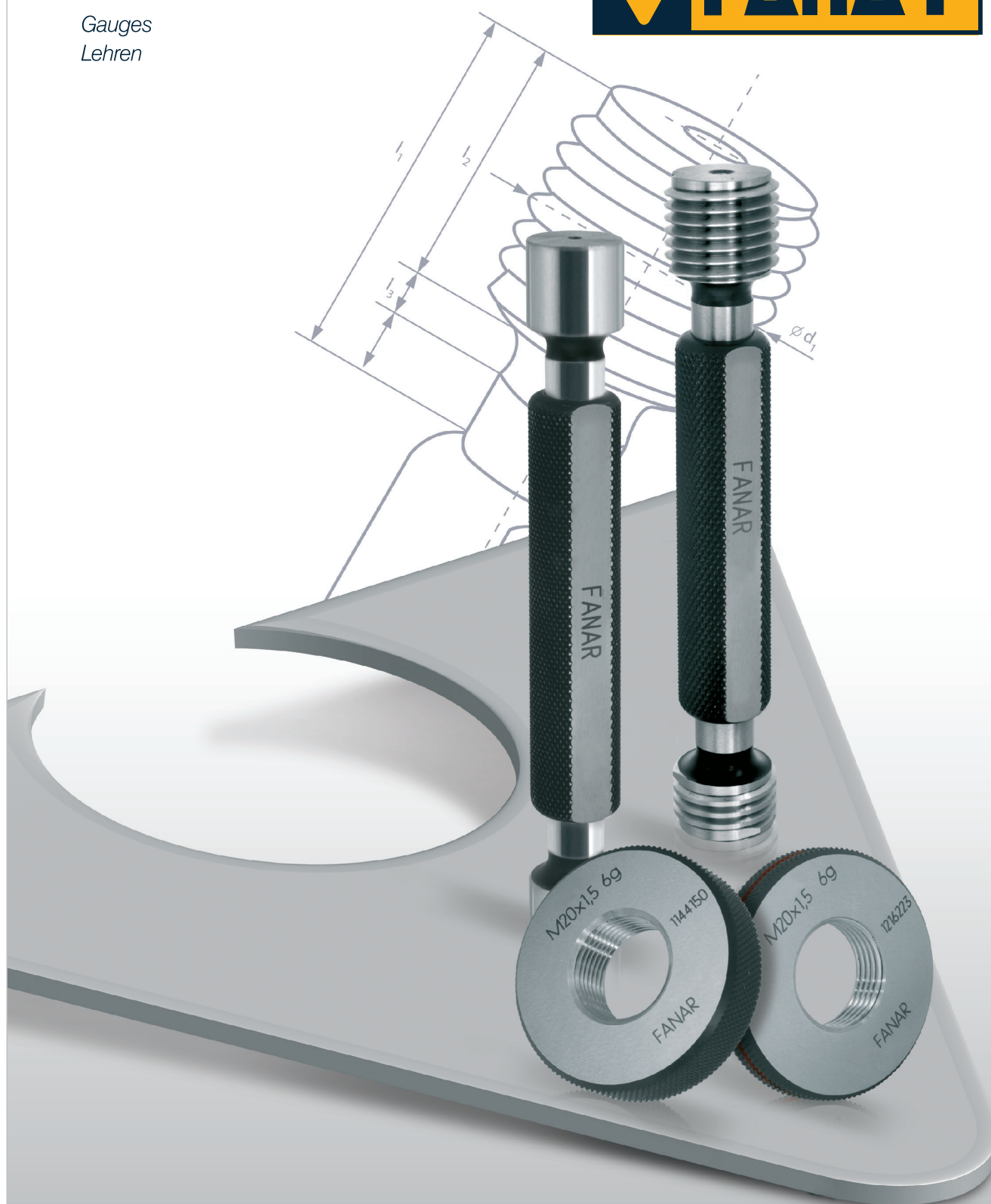

**SPRAWDZIANY**GAUGES  
LEHRENStrona  
Page  
Seite

<b>SPRAWDZIANY TŁOCZKOWE DO OTWORÓW - MSBa</b> <i>SMOOTH PLUG GAUGES - MSBa</i> <i>GRENZLEHRDORNE - MSBa</i>		<b>169</b>
<b>SPRAWDZIANY GWINTOWE TRZPIENIOWE I PIERŚCIENIOWE</b> <i>THREAD GAUGES PLUG AND RING</i> <i>GEWINDE-GRENZLEHREN DORNE UND RINGE</i>		<b>170-180</b>
<b>M</b>	MSBg-6H, -LH-6H, -6G MSRh-6g, MSRk-6g	<b>170</b>
<b>MF</b>	MSBg-6H, LH-6H, 6G MSRh-6g, MSRk-6g	<b>171-172</b>
<b>UNC</b>	MSBg-2B, -3B MSRh-2A, MSRk-2A	<b>173</b>
<b>UNF</b>	MSBg-2B, -3B MSRh-2A, MSRk-2A	<b>174</b>
<b>G</b>	MSBg MSRh-A, MSRk-A	<b>175</b>
<b>R Rc/Rp</b>	MSXa MSXc	<b>176</b>
<b>BSW</b>	MSBg MSRh, MSRk	<b>177</b>
<b>NPT</b>	MSXa MSXc	<b>178</b>
<b>Pg</b>	MSBg MSRh, MSRc	<b>179</b>
<b>Tr</b>	MSBg-7H MSRh-7e, MSRk-7e	<b>180</b>

**Typ sprawdzianu / Type of gauge / Lehrentyp:**
**Sp - Przechodni / Go / Gut**
**Sn - Nieprzechodni / No go / Ausschuss**
**Symbol / Symbol / Symbol**

MSBa

MSBa

**Typ / Type / Typ**

Sp / Sn

Sp / Sn

**Tolerancja / Tolerance / Toleranz**

H7

H8

Ø nom.	INDEX						
		S3-100111	S3-100112				
1	0010	●	○				
1,2	0012	●	○				
1,5	0015	●	○				
1,8	0018	●	○				
2	0020	●	○				
2,2	0022	●	○				
2,5	0025	●	○				
2,8	0028	●	○				
3	0030	●	○				
3,5	0035	○	○				
4	0040	●	○				
4,5	0045	○	○				
5	0050	●	○				
6	0060	●	○				
7	0070	○	○				
8	0080	●	○				
9	0090	○	○				
10	0100	●	○				
12	0120	●	○				
14	0140	●	○				
16	0160	●	○				
18	0180	●	○				
20	0200	●	○				
22	0220	●	○				
24	0240	●	○				
25	0250	●	○				
26	0260	●	○				
27	0270	○	○				
28	0280	●	○				
30	0300	●	○				
32	0320	●	○				
33	0330	●	○				
34	0340	●	○				
35	0350	●	○				
36	0360	●	○				
37	0370	●	○				
38	0380	●	○				
40	0400	●	○				
42	0420	●	○				
44	0440	○	○				
45	0450	●	○				
46	0460	○	○				
47	0470	●	○				
48	0480	○	○				
50	0500	●	○				
52	0520	○	○				

**Powyżej Ø52 sprawdziany przechodnie mają symbol MSCb, a nieprzechodnie MSCc i wykonywane są z rękojeściami oddzielnymi**

Go gauges above Ø52 are called MSCb and no go MSCc and they are produced with separate handle

Bei dem Durchmesser über Ø52 mm Gut-Lehrdom unter Bezeichnung MSCb und Ausschuss-Lehrdom unter Bezeichnung MSCc, mit einseitigen Handgriffen

**Przykład zamawiania / Example of order / Beispiel einer Bestellung:**
**S3-100111-0100**  
**MSBa 10 H7**

● Dostępne z magazynu, cena w cenniku

Available from stock, the price in the price list / Ab Lager lieferbar, der Preis in der Preisliste

○ Do szybkiej dostawy, cena na zapytanie

For quick delivery, price on request / Für die schnelle Lieferung, Preis auf Anfrage

**Gwint metryczny zwykły ISO DIN-13**

ISO Metric coarse thread DIN-13

Metrisches ISO-Regelgewinde DIN-13

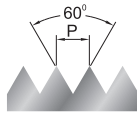
**Zestaw sprawdzianów**

Set of gauges

Satz der Gewindelehrdörne

**CZD-8 MSBg M3÷M12**

Index: Z3-302161-0312

**Typ sprawdzianu / Type of gauge / Lehrentyp:****Sp - Przechodni / Go / Gut****Sn - Nieprzechodni / No go / Ausschuss****Symbol / Symbol / Symbol**

MSBg

MSBg  
LH

MSBg

MSRh

MSRk

**Typ / Type / Typ**

Sp / Sn

Sp / Sn

Sp / Sn

Sp

Sn

**Tolerancja / Tolerance / Toleranz**

6H

6H

6G

6g

6g

M	P	INDEX	S3-302161	S3-301161	S3-302162	Y3-412162	Y3-422162
M 1	0,25	0010	●	○	○	●	●
M 1,2	0,25	0012	●	○	○	●	●
M 1,4	0,3	0014	●	○	○	●	●
M 1,6	0,35	0016	●	○	○	●	●
M 1,7	0,35	0017	●	○	○	●	●
M 1,8	0,35	0018	●	○	○	●	●
M 2	0,4	0020	●	○	○	●	●
M 2,2	0,45	0022	●	○	○	●	●
M 2,5	0,45	0025	●	○	○	●	●
M 2,6	0,45	0026	●	○	○	●	●
M 3	0,5	0030	●	○	○	●	●
M 3,5	0,6	0035	●	○	○	●	●
M 4	0,7	0040	●	○	○	●	●
M 4,5	0,75	0045	●	○	○	●	●
M 5	0,8	0050	●	○	○	●	●
M 6	1	0060	●	○	○	●	●
M 7	1	0070	●	○	○	●	●
M 8	1,25	0080	●	○	○	●	●
M 9	1,25	0090	●	○	○	●	●
M 10	1,5	0100	●	○	○	●	●
M 12	1,75	0120	●	○	○	●	●
M 14	2	0140	●	○	○	●	●
M 16	2	0160	●	○	○	●	●
M 18	2,5	0180	●	○	○	●	●
M 20	2,5	0200	●	○	○	●	●
M 22	2,5	0220	●	○	○	●	●
M 24	3	0240	●	○	○	●	●
M 27	3	0270	●	○	○	●	●
M 30	3,5	0300	●	○	○	●	●
M 33	3,5	0330	●	○	○	●	●
M 36	4	0360	●	○	○	●	●
M 39	4	0390	●	○	○	●	●
M 42	4,5	0420	●	○	○	●	●
M 45	4,5	0450	●	○	○	●	●
M 48	5	0480	●	○	○	●	●
M 52	5	0520	●	○	○	●	●

**Powyżej M52 sprawdziany przechodnie mają symbol MSCh, a nieprzechodnie MSCK i wykonywane są z rękojeściami oddzielnymi**

Go gauges above M52 are called MSCh and no go MSCK and they are produced with separate handle.

Bei dem Durchmesser über  $\text{AE}52$  mm Gut-Lehrdorn unter Bezeichnung MSCh und Ausschuss-Lehrdorn unter Bezeichnung MSCK, mit einseitigen Handgriffen.

Przykład zamawiania / Example of order / Beispiel einer Bestellung:

S3-302161-0030  
MSBg M3 6H

● Dostępne z magazynu, cena w cenniku

Available from stock, the price in the price list / Ab Lager lieferbar, der Preis in der Preisliste

○ Do szybkiej dostawy, cena na zapytanie

For quick delivery, price on request / Für die schnelle Lieferung, Preis auf Anfrage

**Gwint metryczny drobnozwojny ISO DIN-13**

ISO Metric fine thread DIN-13

Metrisches ISO-Feingewinde DIN-13

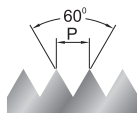
**Typ sprawdzianu / Type of gauge / Lehrentyp:**
**Sp - Przechodni / Go / Gut**
**Sn - Nieprzechodni / No go / Ausschuss**

**Symbol / Symbol / Symbol**

MSBg

 MSBg  
LH

MSBg

MSRh

MSRk

**Typ / Type / Typ**

Sp / Sn

Sp / Sn

Sp / Sn

Sp

Sn

**Tolerancja / Tolerance / Toleranz**

6H

6H

6G

6g

6g

MF	P	INDEX	S3-302161	S3-301161	S3-302162	Y3-412162	Y3-422162
M 3 x 0,35	0,35	0031	o	o	o	o	o
M 3,5 x 0,35	0,35	0036	o	o	o	o	o
M 4 x 0,35	0,35	0043	o	o	o	o	o
M 4x0,5	0,5	0041	o	o	o	o	o
M 4,5 x 0,5	0,5	0046	o	o	o	o	o
M 5 x 0,5	0,5	0051	o	o	o	o	o
M 6 x 0,5	0,5	0061	o	o	o	o	o
M 6 x 0,75	0,75	0062	o	o	o	o	o
M 8 x 0,5	0,5	0081	o	o	o	o	o
M 8 x 0,75	0,75	0082	o	o	o	o	o
M 8 x 1	1	0083	●	●	o	●	●
M 9 x 1	1	0093	o	o	o	o	o
M 10 x 0,75	0,75	0102	o	o	o	o	o
M 10 x 1	1	0103	●	●	o	●	●
M 10 x 1,25	1,25	0104	●	●	o	●	●
M 11 x 1	1	0113	o	o	o	o	o
M 12 x 1	1	0123	●	●	o	●	●
M 12 x 1,25	1,25	0124	●	●	o	●	●
M 12 x 1,5	1,5	0125	●	●	o	●	●
M 13 x 1	1	0133	o	o	o	o	o
M 14 x 1	1	0143	o	o	o	o	o
M 14 x 1,25	1,25	0144	o	o	o	o	o
M 14 x 1,5	1,5	0145	●	●	o	●	●
M 15 x 1	1	0153	o	o	o	o	o
M 15 x 1,5	1,5	0155	o	o	o	o	o
M 16 x 1	1	0163	●	●	o	●	●
M 16 x 1,5	1,5	0165	●	●	o	●	●
M 18 x 1	1	0183	o	o	o	o	o
M 18 x 1,5	1,5	0185	●	●	o	●	●
M 18 x 2	2	0186	o	o	o	o	o
M 20 x 1	1	0203	●	●	o	●	●
M 20 x 1,5	1,5	0205	●	●	o	●	●
M 20 x 2	2	0206	o	o	o	o	o
M 22 x 1	1	0223	o	o	o	o	o
M 22 x 1,5	1,5	0225	●	●	o	●	●
M 22 x 2	2	0226	●	●	o	●	●
M 24 x 1	1	0243	o	o	o	o	o
M 24 x 1,5	1,5	0245	●	●	o	●	●
M 24 x 2	2	0246	●	●	o	●	●
M 25 x 1,5	1,5	0255	●	o	o	o	o
M 26 x 1,5	1,5	0265	●	o	o	o	o
M 27 x 1,5	1,5	0275	●	o	o	o	o

Przykład zamawiania / Example of order / Beispiel einer Bestellung:

**S3-302162-0083**  
**MSBg M8x1 6G**

● Dostępne z magazynu, cena w cenniku

Available from stock, the price in the price list / Ab Lager lieferbar, der Preis in der Preisliste

○ Do szybkiej dostawy, cena na zapytanie

For quick delivery, price on request / Für die schnelle Lieferung, Preis auf Anfrage

## Gwint metryczny drobnozwojny ISO DIN-13

ISO Metric fine thread DIN-13

Metrisches ISO-Feingewinde DIN-13

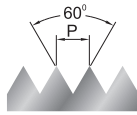

Typ sprawdzianu / Type of gauge / Lehrentyp:

Sp - Przechodni / Go / Gut

Sn - Nieprzechodni / No go / Ausschuss

Symbol / Symbol / Symbol

Typ / Type / Typ

Tolerancja / Tolerance / Toleranz

MF	P	INDEX	S3-302161	S3-301161	S3-302162	Y3-412162	Y3-422162
M 27 x 2	2	0276	●	○	○	○	○
M 28 x 1,5	1,5	0285	●	○	○	○	○
M 28 x 2	2	0286	○	○	○	○	○
M 30 x 1	1	0303	○	○	○	○	○
M 30 x 1,5	1,5	0305	●	○	○	○	○
M 30 x 2	2	0306	●	○	○	○	○
M 32 x 1,5	1,5	0325	●	○	○	○	○
M 33 x 1,5	1,5	0335	●	○	○	○	○
M 33 x 2	2	0336	●	○	○	○	○
M 33 x 3	3	0337	○	○	○	○	○
M 34 x 1,5	1,5	0345	○	○	○	○	○
M 35 x 1,5	1,5	0355	●	○	○	○	○
M 36 x 1,5	1,5	0365	●	○	○	○	○
M 36 x 2	2	0366	●	○	○	○	○
M 36 x 3	3	0367	○	○	○	○	○
M 38 x 1,5	1,5	0385	●	○	○	○	○
M 39 x 2	2	0396	●	○	○	○	○
M 39 x 3	3	0397	○	○	○	○	○
M 40 x 1,5	1,5	0405	●	○	○	○	○
M 40 x 2	2	0406	○	○	○	○	○
M 40 x 3	3	0407	○	○	○	○	○
M 42 x 1,5	1,5	0425	●	○	○	○	○
M 42 x 2	2	0426	●	○	○	○	○
M 42 x 3	3	0427	●	○	○	○	○
M 45 x 1,5	1,5	0455	●	○	○	○	○
M 45 x 2	2	0456	●	○	○	○	○
M 45 x 3	3	0457	○	○	○	○	○
M 48 x 1,5	1,5	0485	●	○	○	○	○
M 48 x 2	2	0486	●	○	○	○	○
M 48 x 3	3	0487	●	○	○	○	○
M 50 x 1,5	1,5	0505	○	○	○	○	○
M 50 x 2	2	0506	○	○	○	○	○
M 50 x 3	3	0507	○	○	○	○	○
M 52 x 1,5	1,5	0525	●	○	○	○	○
M 52 x 2	2	0526	●	○	○	○	○
M 52 x 3	3	0527	●	○	○	○	○

Powyżej M52 sprawdziany przechodnie mają symbol MSCh, a nieprzechodnie MSCK i wykonywane są z rękojeściami oddzielnymi

Go gauges above M52 are called MSCh and no go MSCK and they are produced with separate handle.

Bei dem Durchmesser über  $\text{AE}52$  mm Gut-Lehrdom unter Bezeichnung MSCh und Ausschuss-Lehrdom unter Bezeichnung MSCK, mit einseitigen Handgriffen.



MSBg

MSBg  
LH

MSBg

MSRh

MSRk

Sp / Sn

Sp / Sn

Sp / Sn

Sp

Sn

6H

6H

6G

6g

6g

Przykład zamawiania / Example of order / Beispiel einer Bestellung:

Y3-412162-0276  
MSRh M27x2 6g

● Dostępne z magazynu, cena w cenniku

Available from stock, the price in the price list / Ab Lager lieferbar, der Preis in der Preisliste

○ Do szybkiej dostawy, cena na zapytanie

For quick delivery, price on request / Für die schnelle Lieferung, Preis auf Anfrage

**Gwint amerykański  
 zunifikowany UNC, ANSI B-1.1**

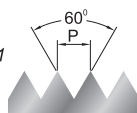
 American unified coarse thread UNC, ANSI B-1.1  
 Amerikanisches Unified - Grobgewinde UNC, ANSI B-1.1

**Typ sprawdzianu / Type of gauge / Lehrentyp:**
**Sp - Przechodni / Go / Gut**
**Sn - Nieprzechodni / No go / Ausschuss**
**Symbol / Symbol / Symbol**
**Typ / Type / Typ**
**Tolerancja / Tolerance / Toleranz**

				MSBg	MSBg	MSRh	MSRk
				Sp / Sn	Sp / Sn	Sp	Sn
				2B	3B	2A	2A
UNC	Ø d <sub>1</sub>	1"/P	INDEX	S3-302186	S3-302187	Y3-412182	Y3-422182
No 5 - 40	3,175	40	4105	●	○	○	○
No 6 - 32	3,505	32	4106	●	○	○	○
No 8 - 32	4,166	32	4108	●	○	○	○
No 10 - 24	4,826	24	4110	●	○	○	○
No 12 - 24	5,486	24	4112	●	○	○	○
1/4 - 20	6,350	20	4127	●	○	○	○
5/16 - 18	7,938	18	4128	●	○	○	○
3/8 - 16	9,525	16	4129	●	○	○	○
7/16 - 14	11,112	14	4130	●	○	○	○
1/2 - 13	12,700	13	4131	●	○	○	○
9/16 - 12	14,288	12	4132	●	○	○	○
5/8 - 11	15,875	11	4133	●	○	○	○
3/4 - 10	19,050	10	4135	●	○	○	○
7/8 - 9	22,225	9	4137	●	○	○	○
1 - 8	25,400	8	4139	●	○	○	○
1.1/8 - 7	28,575	7	4141	○	○	○	○
1.1/4 - 7	31,750	7	4143	○	○	○	○
1.3/8 - 6	34,925	6	4145	○	○	○	○
1.1/2 - 6	38,100	6	4147	○	○	○	○
1.3/4 - 5	44,450	5	4151	○	○	○	○
2 - 4.1/2	50,800	4.1/2	4155	○	○	○	○

Przykład zamawiania / Example of order / Beispiel einer Bestellung:

 S3-302187-4127  
 MSBg 1/4-20 UNC 3B

● Dostępne z magazynu, cena w cenniku

Available from stock, the price in the price list / Ab Lager lieferbar, der Preis in der Preisliste

○ Do szybkiej dostawy, cena na zapytanie

For quick delivery, price on request / Für die schnelle Lieferung, Preis auf Anfrage

**Gwint amerykański zunifikowany  
drobnozwojny UNF, ANSI B-1.1**

American unified fine thread UNF, ANSI B-1.1

Amerikanisches Unified - Feingewinde UNF, ANSI B-1.1

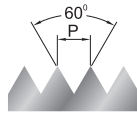

Typ sprawdzianu / Type of gauge / Lehrentyp:

Sp - Przechodni / Go / Gut

Sn - Nieprzechodni / No go / Ausschuss

Symbol / Symbol / Symbol

MSBg

MSBg

MSRh

MSRk

Typ / Type / Typ

Sp / Sn

Sp / Sn

Sp

Sn

Tolerancja / Tolerance / Toleranz

2B

3B

2A

2A

UNF	Ø d <sub>1</sub>	1"/P	INDEX	S3-302186	S3-302187	Y3-412182	Y3-422182
No 5 - 44	3,175	44	4205	○	○	○	○
No 6 - 40	3,505	40	4206	○	○	○	○
No 8 - 36	4,166	36	4208	○	○	○	○
No 10 - 32	4,826	32	4210	○	○	○	○
No 12 - 28	5,486	28	4212	○	○	○	○
1/4 - 28	6,350	28	4227	●	○	○	○
5/16 - 24	7,938	24	4228	●	○	○	○
3/8 - 24	9,525	24	4229	●	○	○	○
7/16 - 20	11,112	20	4230	●	○	○	○
1/2 - 20	12,700	20	4231	●	○	○	○
9/16 - 18	14,288	18	4232	●	○	○	○
5/8 - 18	15,875	18	4233	●	○	○	○
3/4 - 16	19,050	16	4235	●	○	○	○
7/8 - 14	22,225	14	4237	●	○	○	○
1 - 12	25,400	12	4239	●	○	○	○
1.1/8 - 12	28,575	12	4241	○	○	○	○
1.1/4 - 12	31,750	12	4243	○	○	○	○
1.3/8 - 12	34,925	12	4245	○	○	○	○
1.1/2 - 12	38,100	12	4247	○	○	○	○

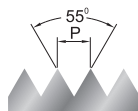

**Gwint rurowy walcowy G, DIN-ISO 228**

 Whitworth pipe thread G, DIN-ISO 228  
 Whitworth Rohrgewinde G, DIN-ISO 228

**Typ sprawdzianu / Type of gauge / Lehrentyp:**
**Sp - Przechodni / Go / Gut**
**Sn - Nieprzechodni / No go / Ausschuss**
**Symbol / Symbol / Symbol**
**Typ / Type / Typ**
**Tolerancja / Tolerance / Toleranz**

G	Ø d <sub>i</sub>	1"/P	INDEX	S3-302180	Y3-412180	Y3-422180
G-1/8"	9,73	28	3123	●	○	○
G-1/4"	13,16	19	3127	●	○	○
G-3/8"	16,66	19	3129	●	●	●
G-1/2"	20,96	14	3131	●	●	●
G-5/8"	22,91	14	3133	○	○	○
G-3/4"	26,44	14	3135	●	●	●
G-7/8"	30,20	14	3137	○	○	○
G-1"	33,25	11	3139	●	●	●
G-1.1/8"	37,90	11	3141	●	○	○
G-1.1/4"	41,91	11	3143	●	○	○



MSBg

MSRh

MSRk

Sp / Sn

Sp

Sn

A

A

Przykład zamawiania / Example of order / Beispiel einer Bestellung:

 S3-302180-3127  
 MSBg G-1/4"

● Dostępne z magazynu, cena w cenniku

Available from stock, the price in the price list / Ab Lager lieferbar, der Preis in der Preisliste

○ Do szybkiej dostawy, cena na zapytanie

For quick delivery, price on request / Für die schnelle Lieferung, Preis auf Anfrage

**Gwint rurowy do połączeń ze szczelnością uzyskiwaną na gwincie**





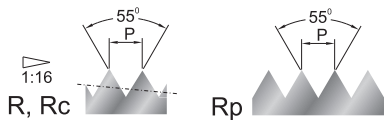

Pipe thread without dry seal material

Rohrgewinde für im Gewinde dichtende Verbindungen

**PN-EN 10226-1,  
PN-EN 10226-2 (ISO7-1:2000)****Typ sprawdzianu / Type of gauge / Lehrentyp:**Patrz strona 236  
See page 266  
Siehe Seite 296**Symbol / Symbol / Symbol**

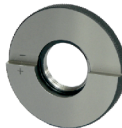
Typ / Type / Typ

**Do gwintu / For thread / Für gewinde**

				PN-EN 10226-3 (ISO7-2:2000)					
									
				MSXa	MSXa	MSXc	MSXc	MSXa	MSXc
				Nr 1	Nr 2	Nr 3	Nr 4	Nr 5	Nr 6
				Rc/Rp	Rc/Rp	R	R	R	Rc
Rc	Ø d <sub>1</sub>	1"/P	INDEX	S3-332101	S3-332102	-	-	S3-332105	-
1/16"	7,72	28	3321	o	o			o	
1/8"	9,73	28	3323	o	o			o	
1/4"	13,16	19	3327	o	o			o	
3/8"	16,66	19	3329	o	o			o	
1/2"	20,96	14	3331	o	o			o	
3/4"	26,44	14	3335	o	o			o	
1"	32,25	11	3339	o	o			o	
1,1/4"	41,91	11	3343	o	o			o	
1,1/2"	47,80	11	3347	o	o			o	
2"	59,61	11	3355	o	o			o	
2,1/2"	75,18	11	3359	o	o			o	
3"	87,88	11	3363	o	o			o	
4"	113,03	11	3371	o	o			o	
R	Ø d <sub>1</sub>	1"/P	INDEX	-	-	Y3-432103	Y3-432104	-	Y3-432106
1/16"	7,72	28	3421			o	o		o
1/8"	9,73	28	3423			o	o		o
1/4"	13,16	19	3427			o	o		o
3/8"	16,66	19	3429			o	o		o
1/2"	20,96	14	3431			o	o		o
3/4"	26,44	14	3435			o	o		o
1"	32,25	11	3439			o	o		o
1,1/4"	41,91	11	3443			o	o		o
1,1/2"	47,80	11	3447			o	o		o
2"	59,61	11	3455			o	o		o
2,1/2"	75,18	11	3459			o	o		o
3"	87,88	11	3463			o	o		o
4"	113,03	11	3471			o	o		o

**Informacje techniczne odnośnie konstrukcji oraz stosowania sprawdzianów R i Rc/Rp w części technicznej katalogu na stronie 266**

Technical information concerning construction and use of gauges R and Rc / Rp in the technical part of the catalogue on page 266

Technische Informationen über den Konstruktion und die Verwendung von Lehren für R-, Rc- und Rp- Rohrgewinde – s. technischer Teil unseres Katalogs auf Seite 326

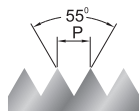

**Gwint calowy zwykły  
 Whitwortha BSW, BS-84:1956**

 Whitworth thread BSW, BS-84:1956  
 Whitworth-Gewinde BSW, BS-84:1956

**Typ sprawdzianu / Type of gauge / Lehrentyp:**
**Sp - Przechodni / Go / Gut**
**Sn - Nieprzechodni / No go / Ausschuss**
**Symbol / Symbol / Symbol**
**Typ / Type / Typ**
**Tolerancja / Tolerance / Toleranz**

BSW	Ø d <sub>1</sub>	1"/P	INDEX	S3-302100	Y3-412100	Y3-422100
1/8 - 40	3,175	40	7123	○	○	○
3/16 - 24	4,762	24	7125	○	○	○
1/4 - 20	6,350	20	7127	○	○	○
5/16 - 18	7,938	18	7128	○	○	○
3/8 - 16	9,525	16	7129	○	○	○
7/16 - 14	11,112	14	7130	○	○	○
1/2 - 12	12,700	12	7131	○	○	○
9/16 - 12	14,288	12	7132	○	○	○
5/8 - 11	15,875	11	7133	○	○	○
3/4 - 10	19,050	10	7135	○	○	○
7/8 - 9	22,225	9	7137	○	○	○
1 - 8	25,400	8	7139	○	○	○
1,1/8 - 7	28,575	7	7141	○	○	○
1,1/4 - 7	31,750	7	7143	○	○	○
1,3/8 - 6	34,925	6	7145	○	○	○
1,1/2 - 6	38,100	6	7147	○	○	○
1,3/4 - 5	44,450	5	7151	○	○	○
2 - 4,1/2	50,800	4,1/2	7155	○	○	○



MSBg

MSRh

MSRk

Sp / Sn

Sp

Sn

medium

medium

medium

**Gwint amerykański rurowy stożkowy  
NPT 1:16, ANSI B-1.20.1**

American tapered pipe thread  
NPT 1:16, ANSI B-1.20.1  
Amerikanisches kegeliges Rohrgewinde  
NPT 1:16, ANSI B-1.20.1

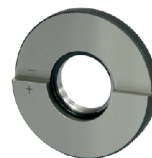
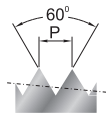

Symbol / Symbol / Symbol

MSXa

MSXc

Typ / Type / Typ

Tolerancja / Tolerance / Toleranz

NPT Ø d <sub>1</sub>	1"/P	INDEX	S3-332100	Y3-432100
1/16"	27	4621	○	○
1/8"	27	4623	○	○
1/4"	18	4627	○	○
3/8"	18	4629	●	○
1/2"	14	4631	●	○
3/4"	14	4635	●	○
1"	11.1/2	4639	●	○
1.1/4"	11.1/2	4643	○	○
1.1/2"	11.1/2	4647	○	○
2"	11.1/2	4655	○	○

**Informacje techniczne odnośnie stosowania sprawdzianów NPT w części technicznej katalogu na stronie 265**
*Technical information concerning use of gauges NPT in the technical part of the catalogue on page 295*
*Technische Informationen über die Verwendung von Lehren für NPT Rohrgewinde – s. technischer Teil unseres Katalogs auf Seite 325*

**Gwint do rurek instalacyjnych stalowych Pg, DIN-40430**

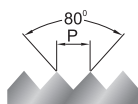
 Steel conduit thread Pg, DIN-40430  
 Stahlpanzerrohr - Gewinde Pg, DIN-40430

**Typ sprawdzianu / Type of gauge / Lehrentyp:**
**Sp - Przechodni / Go / Gut**
**Sn - Nieprzechodni / No go / Ausschuss**
**Symbol / Symbol / Symbol**
**Typ / Type / Typ**
**Tolerancja / Tolerance / Toleranz**

Pg	Ø d <sub>1</sub>	1"/P	INDEX	S3-832100	Y3-412100	Y3-450100
Pg 7	12,5	20	8807	○	○	○
Pg 9	15,2	18	8809	○	○	○
Pg 11	18,6	18	8811	○	○	○
Pg 13,5	20,4	18	8813	○	○	○
Pg 16	22,5	18	8816	○	○	○
Pg 21	28,3	16	8821	○	○	○
Pg 29	37	16	8829	○	○	○
Pg 36	47	16	8836	○	○	○

**Gwint Pg jest zastępowany gwintem metrycznym drobnozwojnym MF wg normy DIN EN 60423 dostępnym na zapytanie**

Pg thread is replaced by metric fine MF according to DIN EN 60423 available on request

Pg-Gewinde wird durch metrisches Feingewinde ersetzt nach Norm DIN EN 60423 auf Anfrage



Przykład zamawiania / Example of order / Beispiel einer Bestellung:

 S3-832100-8807  
 MSBg Pg7

● Dostępne z magazynu, cena w cenniku

Available from stock, the price in the price list / Ab Lager lieferbar, der Preis in der Preisliste

○ Do szybkiej dostawy, cena na zapytanie

For quick delivery, price on request / Für die schnelle Lieferung, Preis auf Anfrage

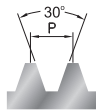
**Gwint trapezowy Tr, DIN-103**Trapezoidal thread Tr, DIN-103  
Trapezgewinde Tr, DIN-103**Typ sprawdzianu / Type of gauge / Lehrentyp:****Sp - Przechodni / Go / Gut****Sn - Nieprzechodni / No go / Ausschuss****Symbol / Symbol / Symbol**

MSBg

MSRh

MSRk

**Typ / Type / Typ**

Sp / Sn

Sp

Sn

**Tolerancja / Tolerance / Toleranz**

7H

7e

7e

Tr Ø d <sub>1</sub> [mm]	P [mm]	INDEX	S3-302171	Y3-412174	Y3-422174
Tr 10 x 2	2	8009	○	○	○
Tr 12 x 3	3	8015	○	○	○
Tr 14 x 3	3	8019	○	○	○
Tr 16 x 4	4	8024	○	○	○
Tr 18 x 4	4	8032	○	○	○
Tr 20 x 4	4	8034	○	○	○
Tr 22 x 5	5	8037	○	○	○
Tr 24 x 5	5	8042	○	○	○
Tr 26 x 5	5	8047	○	○	○
Tr 28 x 5	5	8052	○	○	○
Tr 30 x 6	6	8057	○	○	○
Tr 32 x 6	6	8062	○	○	○
Tr 36 x 6	6	8072	○	○	○

Przykład zamawiania / Example of order / Beispiel einer Bestellung:

S3-302171-8009  
MSBg Tr 10x2 7H

● Dostępne z magazynu, cena w cenniku

Available from stock, the price in the price list / Ab Lager lieferbar, der Preis in der Preisliste

○ Do szybkiej dostawy, cena na zapytanie

For quick delivery, price on request / Für die schnelle Lieferung, Preis auf Anfrage